



**Dehler** 

**42**

2

**Dehler** **42**

VALUES

# A TRUE NEW DEHLER

**Eine Yacht – wie die Dehler 42 – kann man nur bauen, wenn man durch und durch Segler ist.**

Nur wer sein Leben diesem wunderbaren Sport gewidmet hat, bleibt seinen eigenen Werten treu – und entwickelt jede Yacht mit derselben Hingabe, Innovationskraft und Präzision. Wir bei Dehler machen das so seit über 50 Jahren.

**To build a yacht like the Dehler 42, you have to be a sailor through and through.**

Only those who dedicate their life to this wonderful sport will always stay true to their values and develop each yacht with equal commitment, innovative power and precision. At Dehler, we have been doing this for more than 50 years.



3

## VALUES

# PERFECTION IS BASED ON EXPERIENCE

**Ein neues Dehler Modell ist erst vollendet, wenn es nichts mehr zu optimieren gibt.**

Bis dahin fließt unsere ganze Erfahrung aus Jahrzehnten Konstruktionsarbeit, tausenden Yachten und kontinuierlichen Innovationen in die Entwicklung mit ein.

**The creating process of a new Dehler model will only be accomplished once there is nothing left to improve.** Up to this point, all the experience we gained from decades of design work, thousands of yachts and continuous innovations is incorporated into the development.

## 25.314 YACHTS

have been delivered by Dehler since 1963 – an experience that results in excellence.

## 859 INNOVATIONS

that made sailing and living onboard significantly more enjoyable were invented by Dehler.

## 63 MODELS

in all sizes up to 60 feet were created by our designers and developers.

MORE THAN  
**50 YEARS**

of yacht building have continuously increased the demands we place on ourselves and made us one of the leading sailing boat manufacturers.

## 1 PROMISE

follows from all we achieved until today:  
to build the one Dehler 42 you wish for.



## VALUES

# DEHLER 42

## FULL OF IDEAS

**MORE SPEED**

- | Maximized sail area
- | judel/vrolijk & co designed performance hull
- | Light-weight construction
- | Competition options available

**PERFECT QUALITY**

- | Vacuum infusion hull lamination
- | Durable & reliable materials installed

**HIGHEST SAFETY**

- | High righting moment
- | Dehler hull/deck joint
- | Dehler Carbon Cage

**INTELLIGENT FUNCTIONALITY**

- | Sliding chart table
- | Dehler Uni Door Concept

**OUTSTANDING DESIGN**

- | Distinctive window lines
- | Sleek and elegant profile

**BEST RESALE VALUE**

- | Made in Germany
- | Timeless elegance
- | Global customer support

**STRONG INNOVATIONS**

- | Carbon reinforcement in the bottom structure
- | German mainsheet system
- | Integrated plotter pods in coamings
- | Under deck furler
- | Recessed cockpit seats



# OUR VALUES

**In unserem Streben nach dem idealen Schiff lassen wir uns von drei klaren Werten leiten.** Diese Werte haben uns einst zu den Pionieren im deutschen GFK-Bootsbau gemacht – und sie stecken noch heute in jeder Dehler, die unsere Werft verlässt.

**Our passion for creating the perfect yacht is based on three clear values.** These values made us a pioneer in German GRP boat building and can be found today in every Dehler leaving our shipyard.

engineered  
by **Dehler** 

## Value No. 1

### PROCEED WITH SPEED

**Für uns gehört Segelleistung zu den wichtigsten Tugenden einer Yacht.** Warum? Weil es immer wieder begeistert, die Kraft zu spüren, mit der der Bug rasant die Wellen durchschneidet. Und um Begeisterung geht es beim Segeln nun einmal. Deshalb haben auch unsere komfortablen Yachten immer Sport-Genie.

**For us, sailing performance is one of a yacht's most important qualities.** Why? Because it is incredible fun to feel the force the bow exerts when cutting through the waves at a terrific pace; and sailing is simply about having fun. That's why our comfortable yachts have always sports in their DNA, too.

## Value No. 2

### SMART PERFECTION

**Eine perfekte Yacht ist schnell, sicher und schön.** Die Ausstattung lässt keine Wünsche offen. Im Design verschmilzt Funktion mit Ästhetik und die Verarbeitung ist makellos bis ins kleinste Detail. Diesen hohen Ansprüchen fühlen wir uns bei Dehler täglich verpflichtet. Wir bauen jede Yacht so, dass Sie beeindruckt sind von den vielen cleveren Ideen. Wenn alle Lösungen ganz einfach aussehen, obwohl es harte Arbeit war, dann ist es „Smart Perfection“.

**A perfect yacht is fast, safe and beautiful.** Its features meet any desire a sailor might ever have. Its design blends functionality with aesthetics, and the workmanship is flawless, right down to the smallest detail. These are the high standards we are committed to, striving to meet them every day. We build each yacht in such a way that you will be impressed by lots of clever ideas. 'Smart Perfection' is when solutions seem really simple although hard work has been put into them.

## Value No. 3

### GERMAN ENGINEERING

**Dehler steht für die Werte, die „Made in Germany“ zu dem Gütesiegel gemacht haben, das es bis heute ist.** Vor allem zählt für uns Gründlichkeit. Präzision in jedem Detail prägt unser Denken und Handeln sowie die Wahl unserer Partner. Dazu gehören vor allem die international renommierten Yacht-Konstrukteure judel/vrolijk & co. Sichtbar wird dies in zeitlosen Formen mit dynamisch-eleganten Linien.

**Dehler justifies values that turned 'Made in Germany' into the seal of approval that it is today.** Thoroughness counts before everything else. Precision in every detail is what shapes the way we think and act as well as who we choose to be our partners. Most notably, the internationally renowned yacht designers judel/vrolijk & co belong to our partners. Timeless shapes with dynamic, elegant lines are testimony to all of this.



DEHLER 42

# CONTENT

## INHALT

2

VALUES

2 A TRUE NEW  
DEHLER4 PERFECTION  
IS BASED ON  
EXPERIENCE6 DEHLER –  
FULL OF IDEAS

8 OUR VALUES

12

INDIVIDUALITY

12 IT'S UP TO YOU

14 EASY TO SAIL

16 HARD TO BEAT

18 COMPETITION &  
PERFORMANCE  
STYLE

20

EXTERIOR

22 DECK

26 CARBON RIG

28 DEHLER  
FREERIDE SAIL30 TECHNICAL  
SPECIFICATIONS32 MATERIALS &  
COLOURS

38

INTERIOR

40 SALOON &  
PANTRY

46 HEAD

48 CABIN LAYOUTS

52 MATERIALS &  
COLOURS

58

TECHNOLOGY

58 DEEPER INSIDE

62 PACKAGES

64 OPTIONS



## INDIVIDUALITY

IT'S UP  
TO YOU

**Die Dehler 42 ist wandelbar**, wie ein Chamäleon. Fahrtenschiff, Performance-Cruiser, Regattayacht: Ihre Fahrleistungen lassen sich nach Belieben steigern und passen sich Ihrem Segelstil an. Auch unter Deck stehen Ihnen alle Möglichkeiten offen. Hier löst eine Vielfalt an Kabinenlayouts und Materialien unser Versprechen ein: Die Dehler ist immer das, was Sie daraus machen.

**The new Dehler 42 is as changeable** as a chameleon. Touring yacht, performance cruiser, regatta racer – her speed performance can be increased as you like and adapts completely to your personal sailing style. Even below deck, all options are open. Offering a huge variety of cabin layouts and materials, we keep our promise: the Dehler is whatever you make it.

First choice for speedy sailing: **the carbon rig.**High quality **vacuum bonded teak deck.****Stylish and custom made:** the interior of your Dehler 42.

## INDIVIDUALITY

# EASY TO SAIL

**Höchster Segelkomfort gehört bei einer Dehler zur Grundausstattung.** Bestes Beispiel: das German Mainsheet System. Es führt die Großschot auf beiden Cockpitseiten direkt zum Steuerstand. Sie haben alles in Reichweite, was Sie zum Manövrieren brauchen.

**On a Dehler, great sailing comfort is part of the basic equipment.** It comes, for example, with the German Mainsheet System taking the mainsheet on both sides directly to the helm. This makes sure all you need for your manoeuvring is within immediate reach.





## INDIVIDUALITY

# HARD TO BEAT

Mit den richtigen Optionen wird aus dem komfortablen Performance-Cruiser eine Regatta-Yacht. Für Crews von zwei bis acht Mann, für die Wettfahrt mit Freunden – oder um bei internationalen Regatten mit höchstem Niveau auf Sieg zu segeln. Wann starten Sie? Die 42 haben wir – wie jede Dehler – bereits nach OCR Regeln vermessen lassen.

By choosing the right options, you can turn your luxurious performance cruiser into a regatta yacht. For crews with two to eight members, for races with friends – or to compete in international regattas and fight for the victory at the highest level. When do you start? The 42, like every Dehler, has already been measured according to the ORC standard.



## INDIVIDUALITY

18

### COMPETITION STYLE

**A** ERGONOMIC INSTRUMENT POD  
PORT SIDE & STARBOARD

2x B&G multifunction displays,  
Zeus<sup>2</sup> 9" GPS chart plotter

**B** HPM SAILS

lighter and more stable with  
a longer life span

**C** CARBON RIG

lighter and stiffer than aluminium,  
connected to hull with rod rigging

**D** ANTI-SLIP SURFACE

for light weight sailing

**E** BOW SPRIT

increases sailing performance  
with asymmetrical headsails

**F** COMPETITION RUDDER

deeper and thinner construction

**G** COMPETITION STYLE  
COVELINE

elegant and dynamic lines

**H** COMPETITION KEEL

reduced weight and more stability

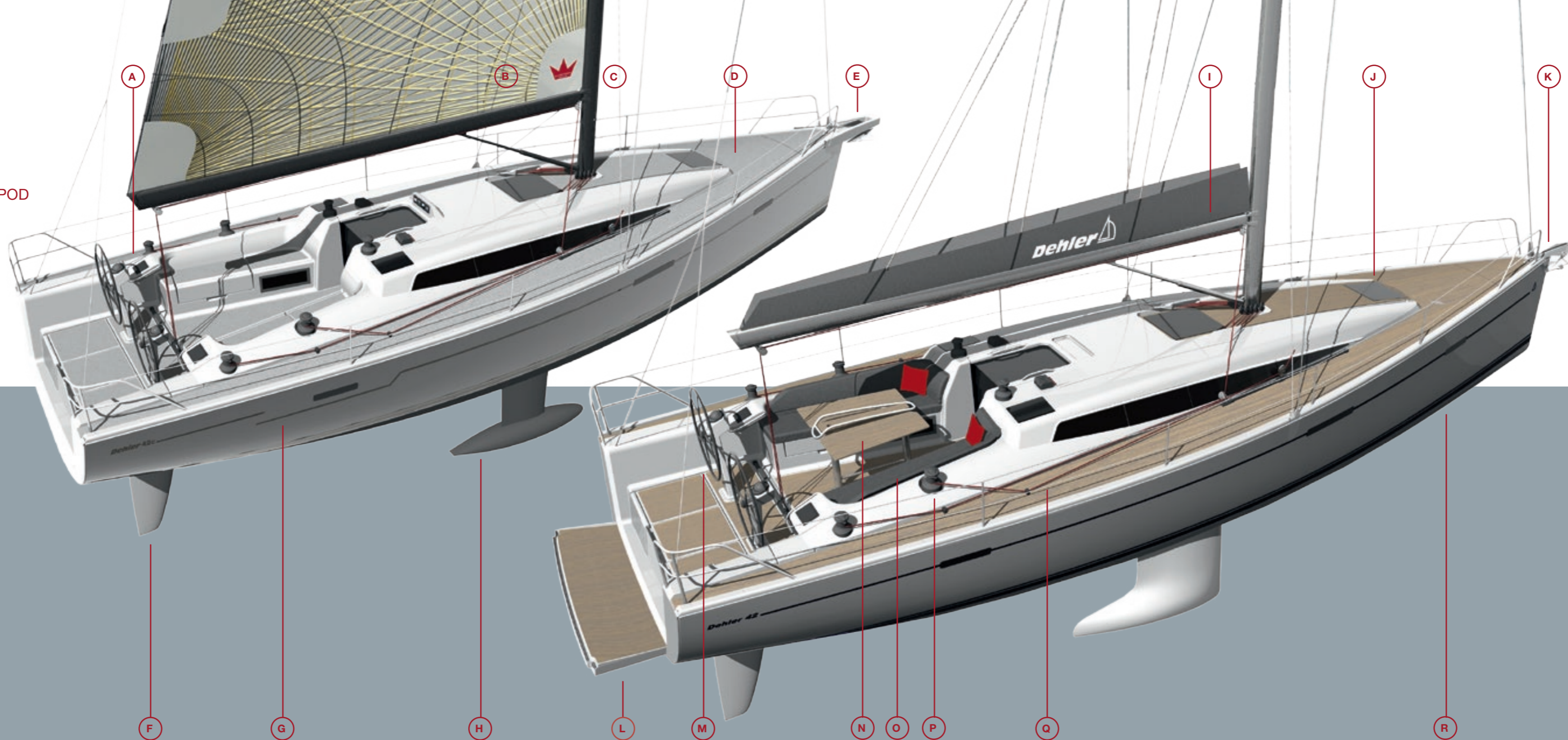

### PERFORMANCE CRUISING STYLE

19

**I** MAINDROP SYSTEM  
and single-line reefing

**J** TEAK ON SIDE DECKS  
natural teak and synthetik available

**K** S/S ANCHOR FITTING  
with chain up to 50 m

**L** BATHING PLATFORM  
for closed transom with integrated  
swimming ladder

**M** Y-SPOKE TWIN  
STEERING WHEEL  
for more comfortable helming

**N** COCKPIT TEAK TABLE  
with retractable LED lamp

**O** CUSTOMIZED  
UPHOLSTERY  
many colours and materials available

**P** SELF TAILING WINCHES  
for comfortable and easy sailing

**Q** GERMAN MAINSHEET  
SYSTEM  
mainsheet control from both  
helmsman positions

**R** RETRACTABLE  
BOWTHRUSTER  
for perfect handling in harbour



**Dehler** 

# 42

EXTERIOR

## CHARACTER THAT MEETS THE EYE

**Die Dehler 42 ist vieles:** Edles Apartment auf See, High-Tech-Sportgerät – und dank ihres Designs ein markantes Bekenntnis zum echten, unverfälschten Segeln.

**The Dehler 42 is many things:** an exquisite apartment at sea, a piece of high-tech sports equipment – and due to her design, a distinctive commitment to the unadulterated kind of sailing.





22

Y-spoke wheels and traveller for perfect sailing.



Wide-opening flush hatch framed with vacuum bonded teak wood.

## EXTERIOR

# DECK

Auf den ersten Blick fällt das klare, aufgeräumte Design des Decks auf. Alle Winschen, Klampen, Rollen und viele weitere clevere Details sind an der richtigen Stelle und genau so positioniert, dass beim sportlichen Segeln alles perfekt zur Hand liegt.

The distinct, clean-cut deck design catches your eye at first glance. All the winches, cleats, rollers and many smart details more are positioned just in the right places, so everything will be close at hand when sailing in a sporty way.



23

Teak-covered side deck with genoa tracks adjustable from the cockpit and openable windows for optimum ventilation.



Electric anchor with remote control.

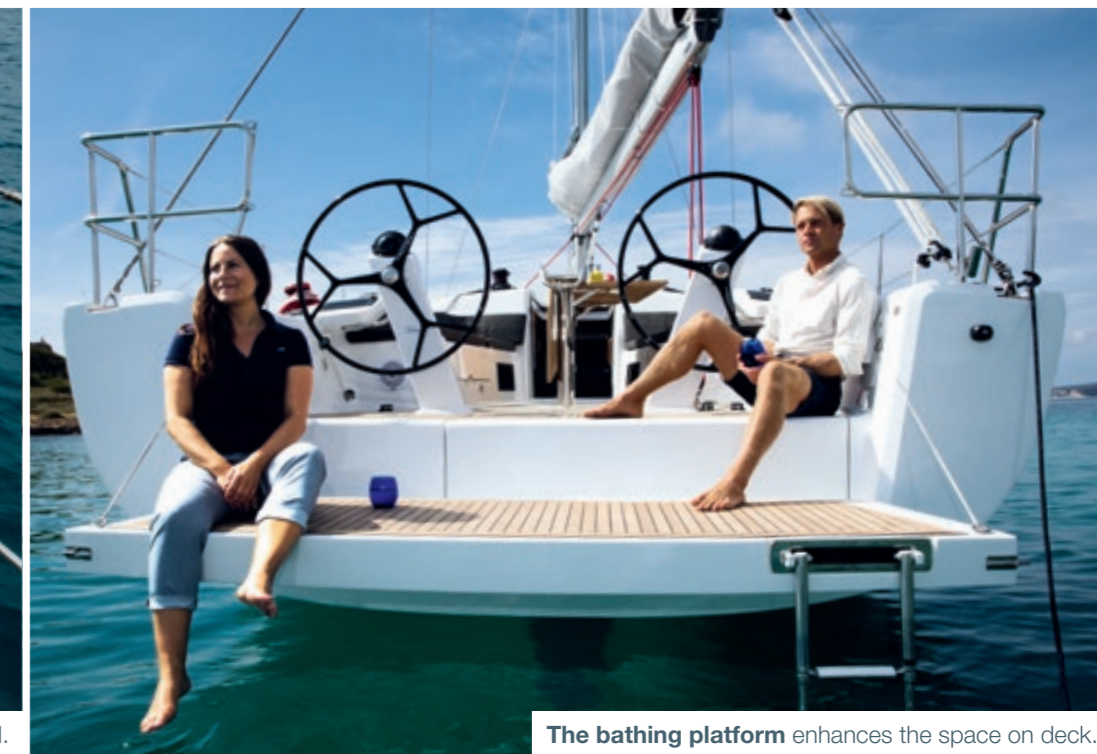

The bathing platform enhances the space on deck.

24



The next Dehler innovation: **recessed cockpit seats** give more safety when sailing.



Keeps the beauty of your yacht: **underdeck furler and rounded spring cleats.**



Smart solution – **the integrated companionway hatch.**



25

Cockpit table with **retractable LED-light.**

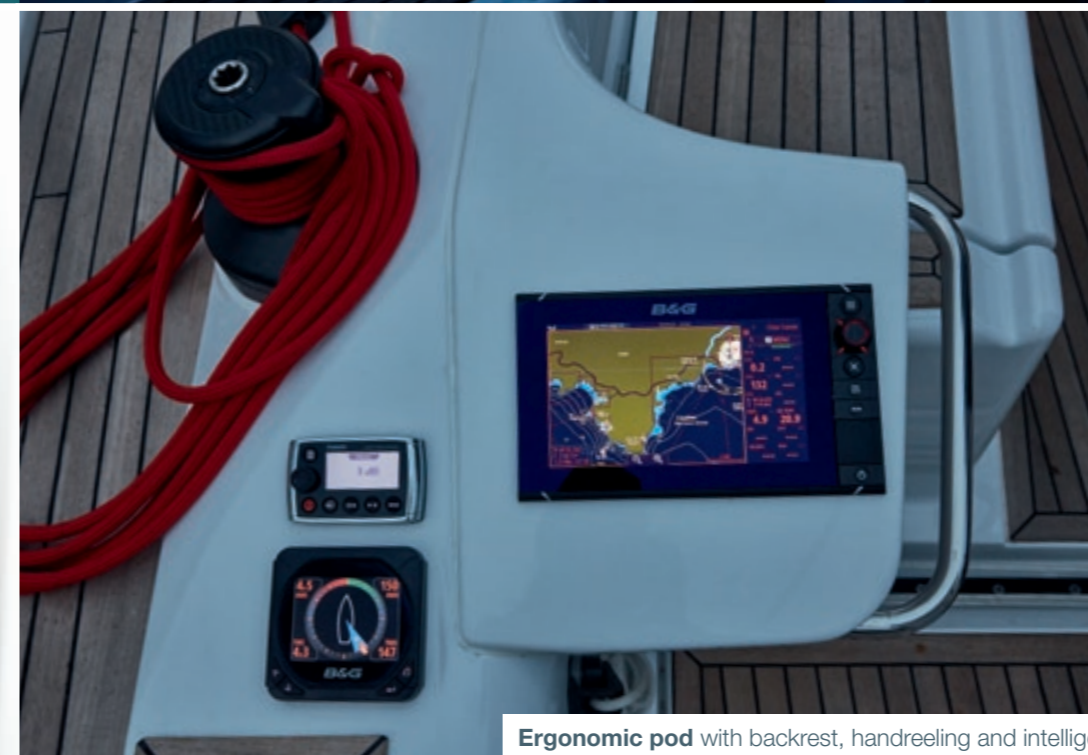

**Ergonomic pod** with backrest, handreeling and intelligent 9" multifunctional navigation display. Starboard with bow thruster control, portside with sound system.

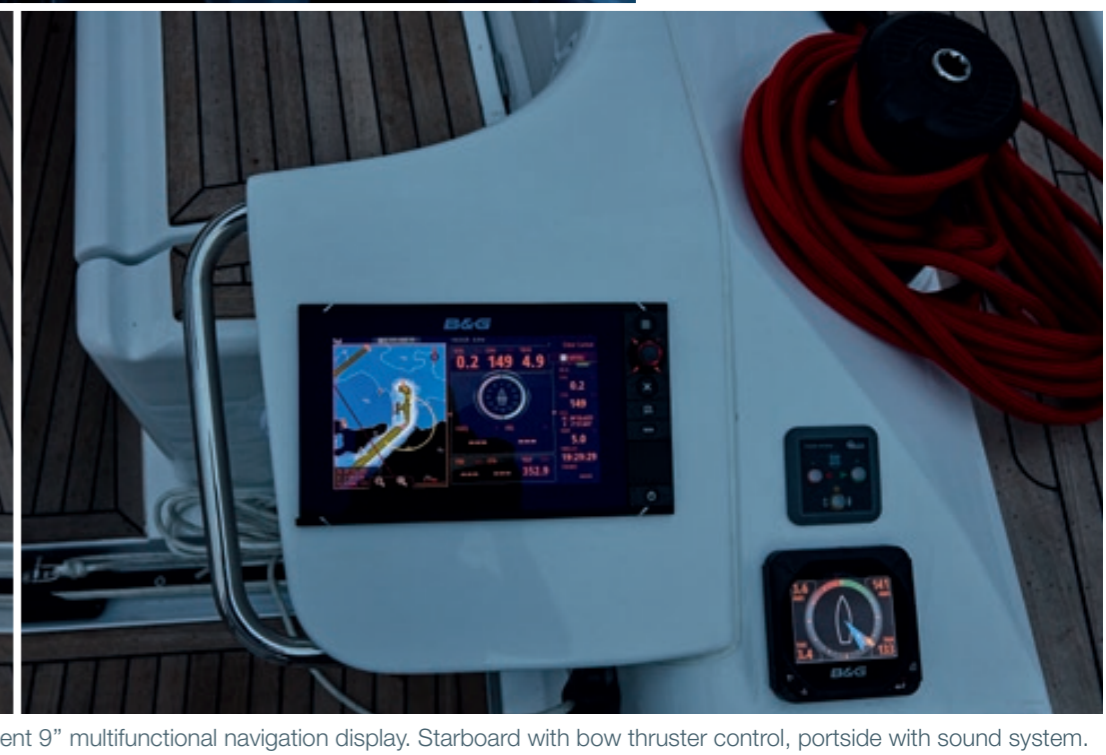

## TECHNICAL RIG SPECIFICATIONS

	ALU RIG
Weight	280 kg / 618 lbs
Shrouds	1x19
Backstay	one-sided
Spreader	alu
Boom	alu
Boom vang	alu
Main sail Sliders	Selden
Total Sail Area	93.50 m <sup>2</sup> / 1,006 sq ft
I	16.44 m / 53'1"
J	4.63 m / 15'2"
P	16.10 m / 52'1"
E	5.70 m / 18'8"

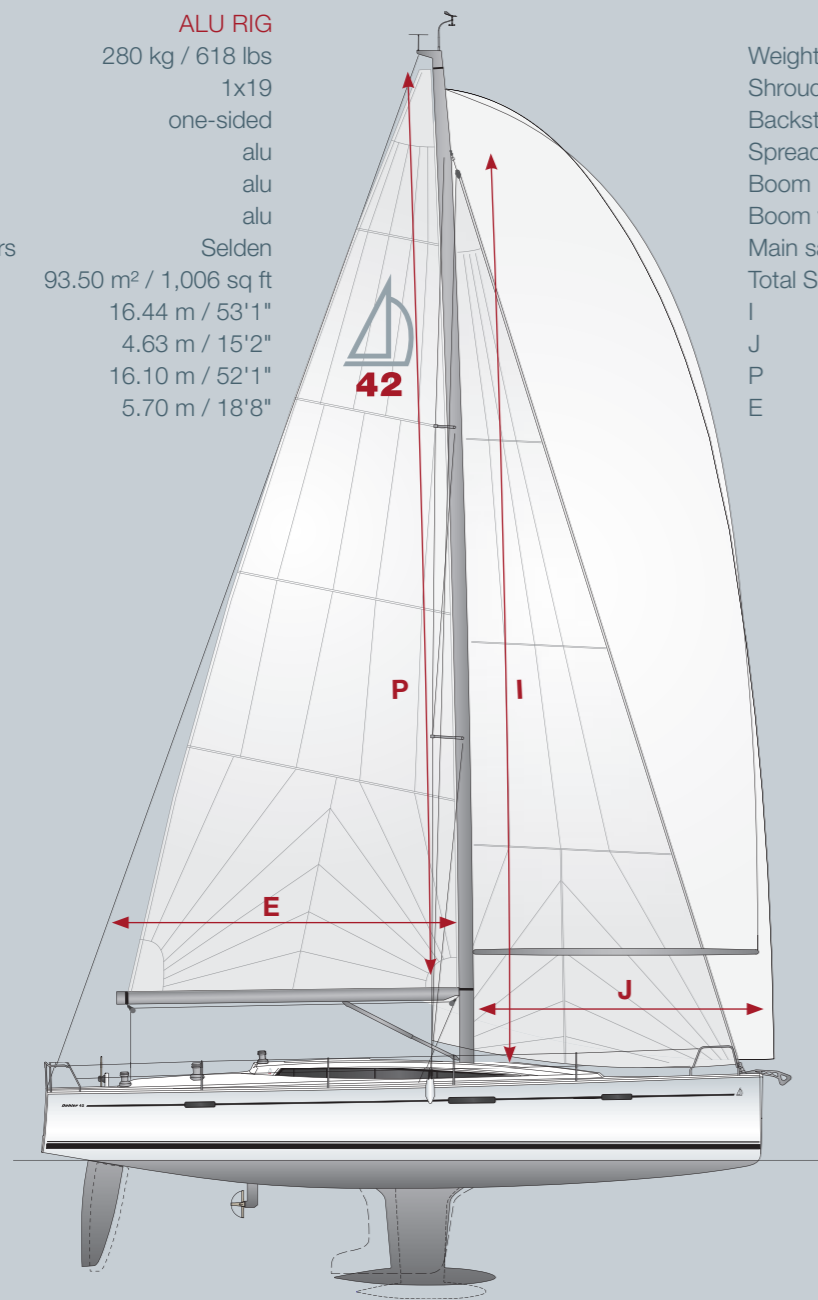

	CARBON RIG
Weight	195 kg / 430 lbs
Shrouds	rod rig
Backstay	one side hydraulic
Spreader	carbon
Boom	carbon
Boom vang	carbon
Main sail Sliders	Antal
Total Sail Area	100.50 m <sup>2</sup> / 1,082 sq ft
I	16.90 m / 55'5"
J	4.63 m / 15'2"
P	16.90 m / 55'5"
E	5.80 m / 19'0"

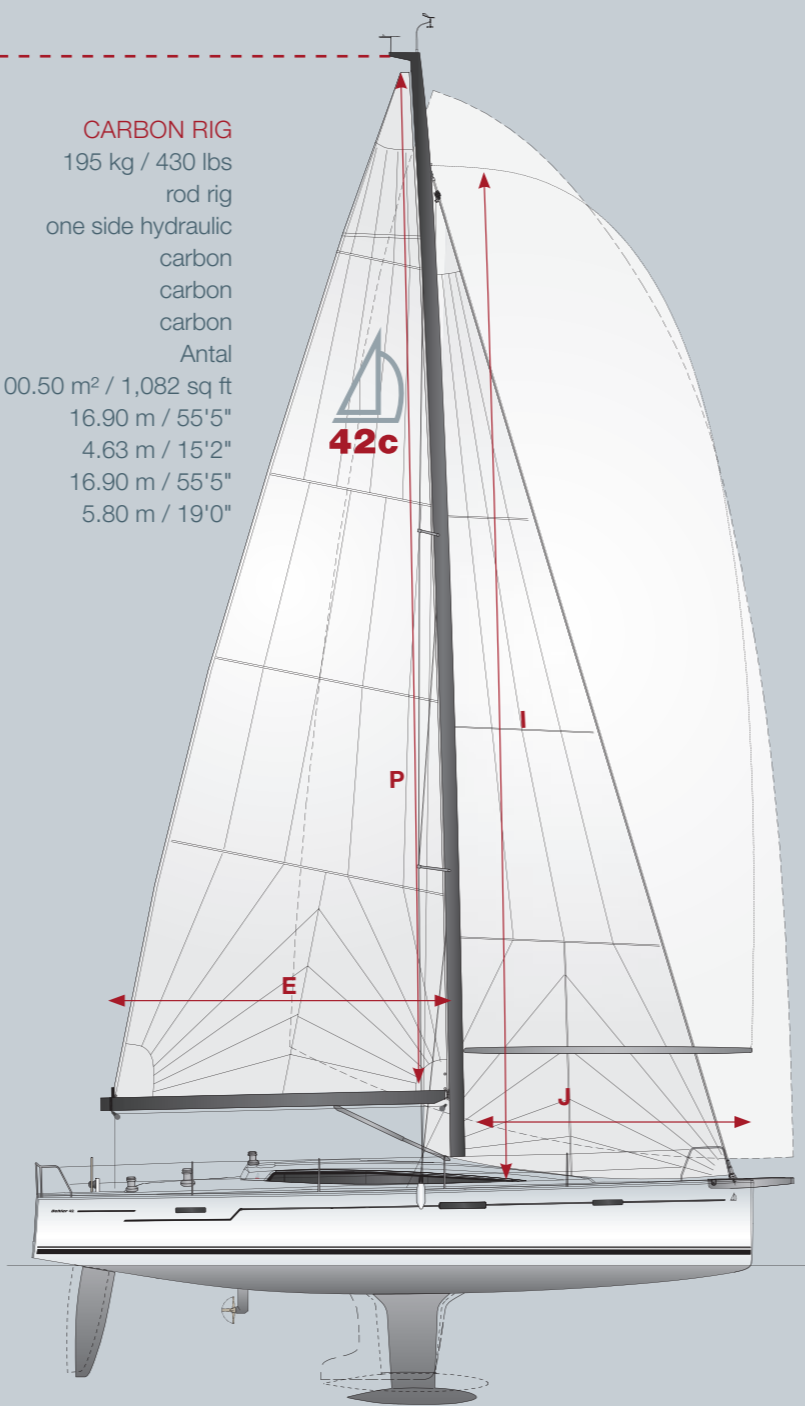

## EXTERIOR

# CARBON RIG

Unser Rigg aus dem High-tech Werkstoff Karbon bringt entscheidende Vorteile: Der Mast ist länger, leichter und steifer als der Standard-Alu-Mast, bietet eine größere Segelfläche – und damit ein Mehr an Segelleistung bei leichtem Wind und bei Seegang. Zudem sind die Karbonteile witterungsbeständiger und langlebiger als Aluminium.

Making our rig of the high-tech material carbon provides decisive advantages: The mast is longer, lighter and stiffer than the standard alu mast. It enlarges the sail area which increases the seailing performance in rough seas and under low-wind conditions. In addition, the carbon parts are more weather-resistant than aluminium.

## BOOST YOUR SAIL PERFORMANCE BY 20 S/NM

When equipped with HPM sails and carbon rig, competition rudder and deep keel, your Dehler 42 can sail significantly faster:

- | 85 kg less rig weight
- | 7 m<sup>2</sup> more sail area and
- | 650 kg less overall weight

As a result the yacht is approx. 20 s/nm faster, achieving an ORC value of **GPH 580 s/nm**.



### Sail Performance

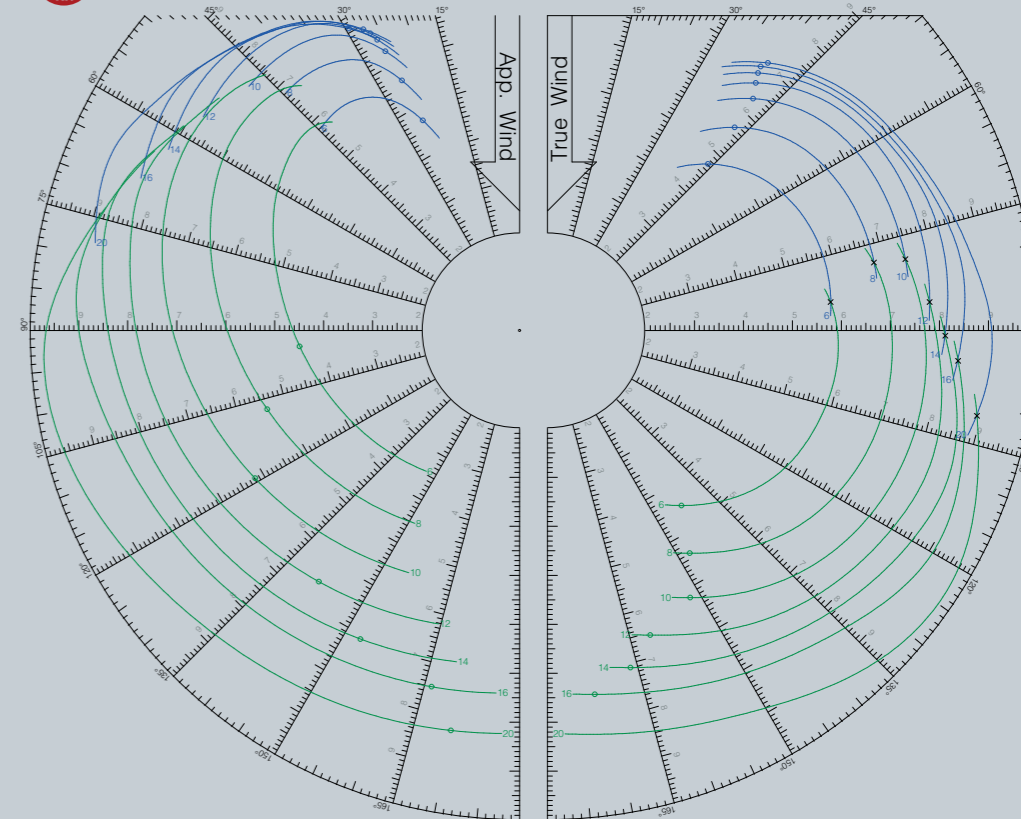



PERFORMANCE SAILS

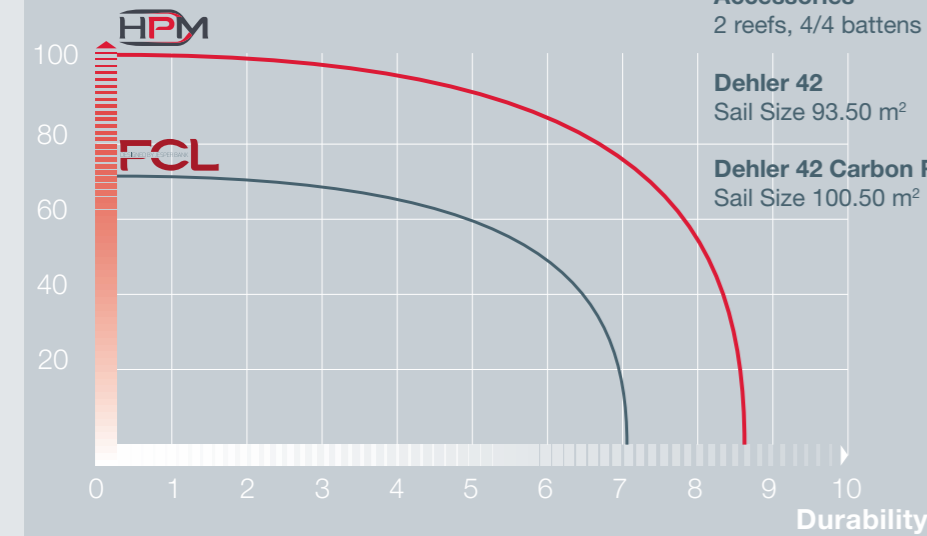

Layout / Cloth



Accessories

2 reefs, 4/4 battens

Dehler 42

Sail Size 93.50 m<sup>2</sup>

Dehler 42 Carbon Rig

Sail Size 100.50 m<sup>2</sup>

NEW!

# DEHLER FREERIDE SAIL

Das neue Dehler FREERIDE SAIL ist die perfekte Segelgröße zwischen Genua und Gennaker und hat den größten Wind-einsatzbereich seiner Klasse. Das heißt: Vom Am-Wind-Kurs bis zum tiefen Raumkurs bringt das FREERIDE SAIL Ihre Dehler auf Geschwindigkeit.

Dabei ist es ein voll einhandaugliches Segel. Es wird aus dem speziell entwickelten Sailbag vom Deck gesetzt. Mit zwei Klicks am eigenen Vorstag befestigt, kann es im Hafen eingerollt gesetzt bleiben.

The new Dehler FREERIDE SAIL is the perfect intermediate size between genoa and gennaker, offering the largest wind range in its class. That means, the FREERIDE SAIL speeds up your Dehler, no matter if your are sailing a close reach or broad reach course.

Fully optimised for single-handed sailing, it is set from the deck, coming out of a specially developed sailbag. Two clicks are all it takes to fix the sail to its separate forestay. Back in the port, just keep the furled-up sail attached.

## DEHLER FREERIDE SAIL

- | 72 m<sup>2</sup> sail area, for wind speeds starting at 5 kn
- | Made of CZ laminate with trioptimal cut – a very lightweight pale grey material containing Twaron high-performance fibres and black Technora X – Ply
- | Quickly fixed with just two clicks and rolled out
- | High-grade furling system and special furling cable included
- | Specially developed weatherproof sailbag

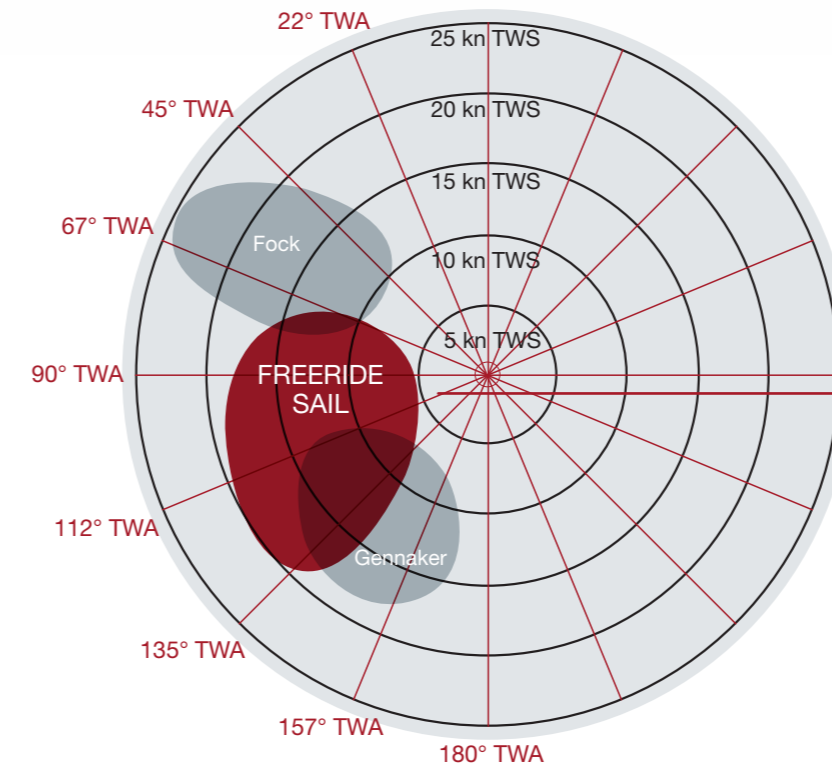

wind range starting at 5 kn

UV-protected

integrated furling cable and endless furling system



FREERIDE SAIL: 72 m<sup>2</sup>

JIB: 41 m<sup>2</sup>

MAINSAIL: 52.5 m<sup>2</sup>

## EXTERIOR

# TECHNICAL SPECIFICATIONS

**Zu den vielfältigen Ausstattungsoptionen** gehören z. B. ein Teak-Deck oder die komfortable Badeplattform, die den Zugang zum Wasser erleichtert und die Decksfläche erheblich vergrößert. Die sportliche Variante spart Gewicht u. a. mit einem Karbon-Rigg, tiefem T-Kiel, langem Ruder und Laminatsegeln.

**The versatile equipment options** include a teak deck and the convenient bathing platform, which makes it easier to access the water and considerably enlarges the area of the deck. The sports version includes a carbon rig, T-speed-keel, deeper rudder, laminate sails and thus carries less weight.

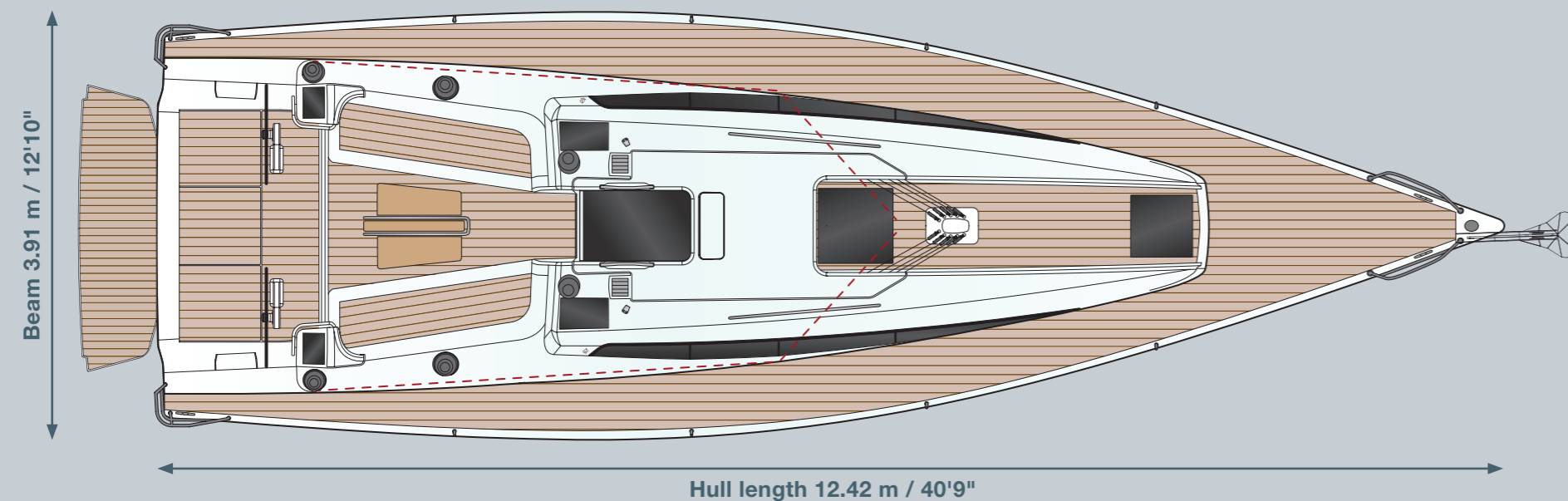

## TECHNICAL SPECIFICATIONS

### HULL

LOA	12.84 m	42'1"
Hull length	12.42 m	40'9"
LWL	11.50 m	37'9"
Beam	3.91 m	12'10"

### DRAUGHT

Standard	2.15 m	7'1"
Competition	2.38 m	7'10"
Shallow	1.98 m	6'5"

### DISPLACEMENT

Standard	9.10 t	20,062 lbs
Competition	8.45 t	18,629 lbs
Shallow	9.35 t	20,613 lbs

### BALLAST

Standard	3.00 t	6,614 lbs
Competition	2.60 t	5,732 lbs
Shallow	3.25 t	7,165 lbs

### ENGINE

Volvo D2-40	38.00 HP	27.90 kW
-------------	----------	----------

### TANKS

Fresh water approx.	315 l
Fuel tank approx.	160 l

### CE CERTIFICATE

Class A

### HULL DESIGN

judel/vrolijk & co.

### INTERIOR DESIGN

Dehler

### MAST

Length above WL		
Standard	19.50 m	63'12"
Competition	20.25 m	66'5"

### TOTAL SAIL AREA

Standard	93.50 m <sup>2</sup>	1,006 sq ft
Competition	100.50 m <sup>2</sup>	1,082 sq ft

### MAINSAIL

Standard	52.50 m <sup>2</sup>	565 sq ft
Competition	57.50 m <sup>2</sup>	619 sq ft

### FURLING JIB

Standard (105 %)	41.00 m <sup>2</sup>	441 sq ft
Competition (105 %)	43.00 m <sup>2</sup>	463 sq ft

### SPINNAKER

Standard	130.00 m <sup>2</sup>	1,399 sq ft
Competition	130.00 m <sup>2</sup>	1,399 sq ft

### GENNAKER

Standard	120.00 m <sup>2</sup>	1,292 sq ft
Competition	145.00 m <sup>2</sup>	1,561 sq ft

### FREERIDE SAIL

Standard	72.00 m <sup>2</sup>	775 sq ft
Competition	78.90 m <sup>2</sup>	849 sq ft

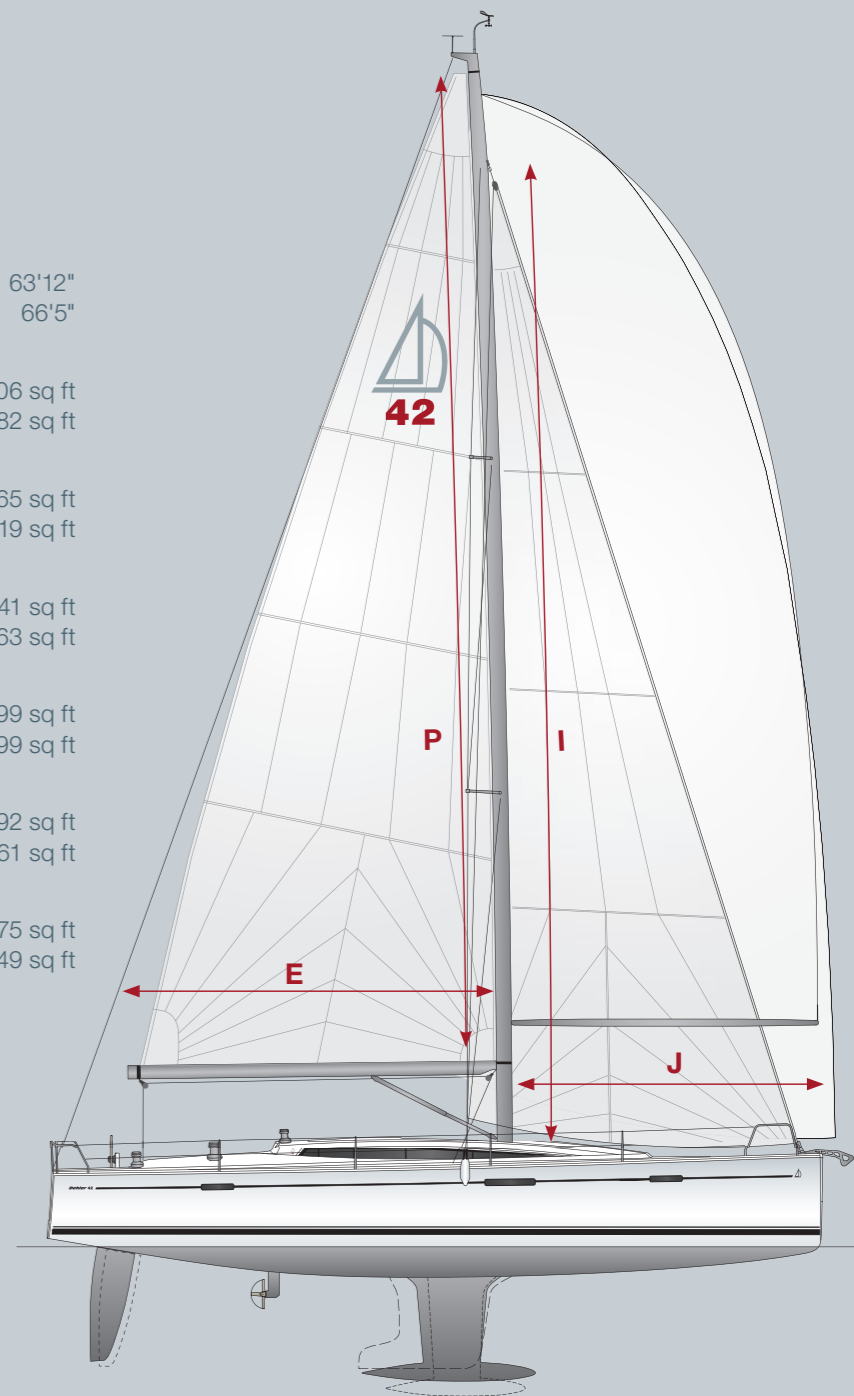



## EXTERIOR

MATERIALS  
& COLOURS

Die Farbe des Rumpfes, der Stil des Teak-Decks: Erst mit der Gestaltung der Oberflächen verleihen Sie dem Exterieur seinen letzten Schliff. Besonders interessante optische Akzente lassen sich z. B. auch beim Cockpitpolster oder Sprayhood setzen.

The colour of the hull, the style of the teak deck: It is your personal surface design that applies the finishing touches to the exterior. If you like to set striking visual accents, lazy bag and sprayhood provide the best surface to do so.

## EXTERIOR | GELCOAT HULL, WATERLINE &amp; DECORLINE

Gelcoat Hull, Waterline and Decorline can be matched according to the gelcoat selection chart. Your dealer will be happy to advise you.

## STANDARD



## OPTIONS



# EXTERIOR | PAINTED HULL, WATERLINE & DECORLINE

**Mix and match as you wish.**

The hull, waterline & decorline can also be painted in 70 + more other colors according to Alexseal color selection. Your dealer will be happy to advise you.

## OPTIONS

Shown are examples. All colours can be matched.



# EXTERIOR | COVERS & UPHOLSTERY

36

Maindrop, Sprayhood, Cockpit Canopy, Steering Wheel Cover, Cockpit Table Cover



# EXTERIOR | NATURAL TEAK & SYNTHETIC TEAK

37

NATURAL TEAK OPTION

SYNTHETIC TEAK OPTIONS

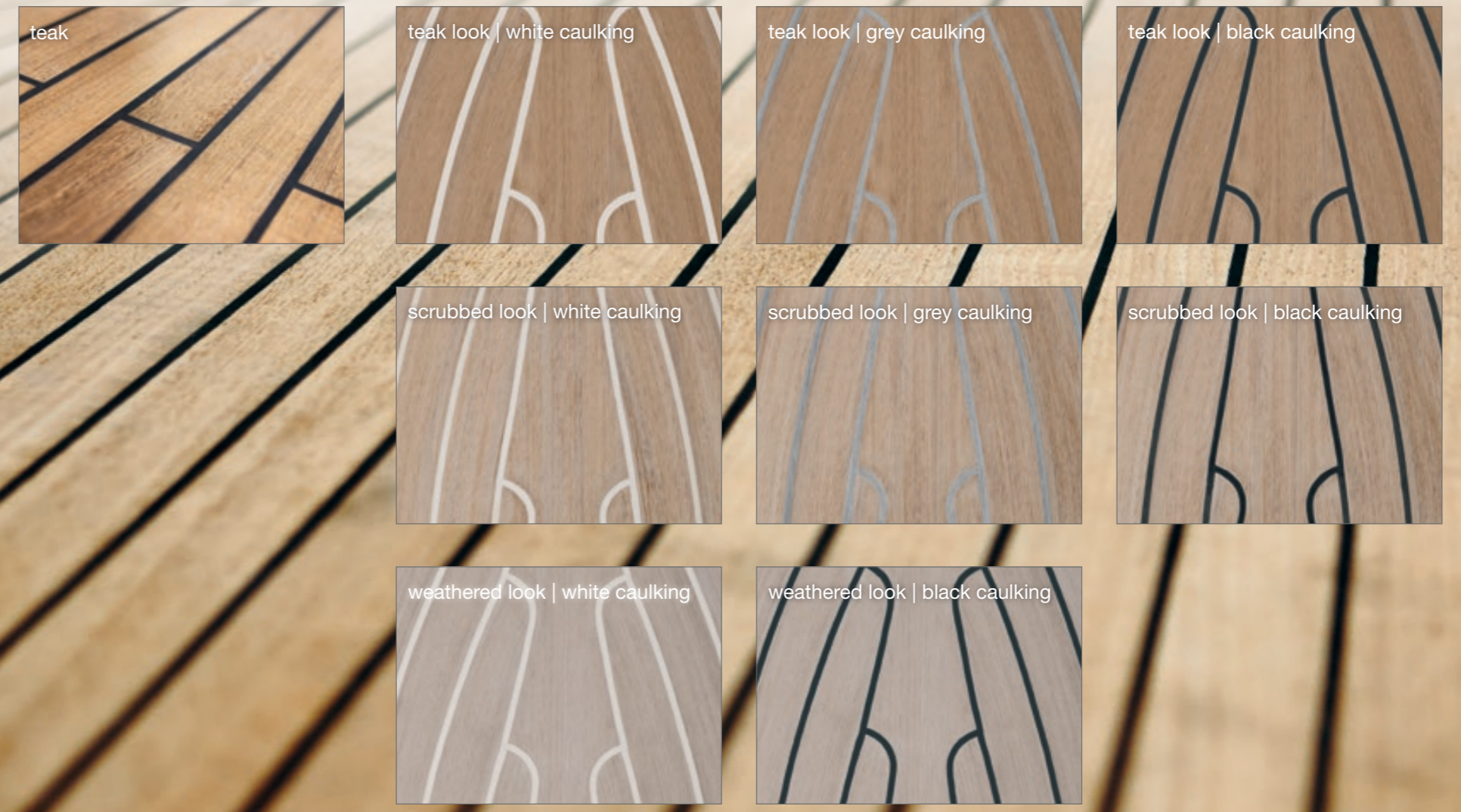

**Dehler** **42**

INTERIOR

# DESIGNED TO MAKE YOU FEEL AT HOME

Machen Sie es sich bequem. Gestalten Sie den harmonischen Innenraum mit seinen elegant fließenden Formen nach Ihren Wünschen.

Make yourself comfortable. Style the harmonious and elegantly shaped interior according to your preferences.





Shift the chart table to increase seating space or to create another bunk.



Cleverly hidden: the saloon table features a **retractable bar**.

## INTERIOR

# SALOON & PANTRY

Der **zentrale Bereich im Inneren** bietet zahlreiche bemerkenswerte Lösungen zur optimalen Raumnutzung, so lassen sich zum Beispiel die Salonschränke mit ihren markanten Rundungen praktischerweise nach oben öffnen.

The **central area of the interior** provides many remarkable ways of using space efficiently. For example, the saloon cabinets with their distinctive curves open upwards in a practical fashion.



A feast for the eye: gently **rounded shapes** and **superb mahogany woodwork**.

42



Large two-part sink. Put on both covers to use it as a worktop.



Another smart detail: wooden stove cover serving as cutting board.

43



Fold up the seating surface and your chaiselongue is ready for relaxing or a nap.

44



Very comfortable: **rounded headrests.**



**Retractable TV** in the salon.

45



**Lots of storage possibilities** under the seats.



Another styling option: **worktop galley in black.**

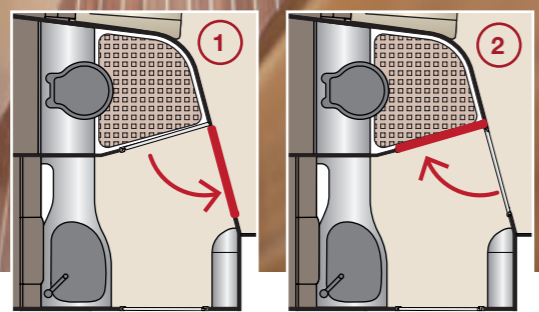

**Dehler Uni Door Concept**

1. The door swings open one way towards a roomy bathroom that is separate from the lounge.
2. When the door swings the other way, it closes the shower and toilet room instead.

## INTERIOR HEAD

**Darauf sind wir stolz:** das neue Dehler Uni Door Concept, das Ihnen stets die Wahl zwischen zwei Raum-Layouts lässt. Der Clou dabei ist eine Tür für drei Räume. Schwingt die Tür zur einen Seite, entsteht ein geräumiges Badezimmer, das vom Salon getrennt ist. Schwingt sie zur anderen, verschließt sie stattdessen den Raum mit Dusche und WC. Gleichzeitig gibt sie den Durchgang vom Waschbereich zum Salon frei, was ein besonders großzügiges Raumgefühl schafft.

**We are proud of** our new Dehler Uni Door Concept, which always gives you a choice between two room layouts. Its key feature is having one door for two frames. The door swings open one way onto a roomy bathroom that is separate from the lounge. When the door swings the other way, it closes the shower and toilet room instead. The hallway from the wash area to the saloon is free at the same time, making the room feel very spacious.



**Dehler Uni Door Concept:** door closes the shower and toilet room.



Around the washbasin, there is **enough space to place all your toiletries.**



Put on the cover to create a **full-width seat in the toilet room.**





Head owner's cabin.

## INTERIOR CABIN LAYOUTS

In der Standard-Version verfügt die Dehler 42 über eine Vorschiffkabine, eine geräumige Achterkabine Steuerbord und einen großen, begehbaren Stauraum Backbord, den Sie als Segellast oder für sonstige Bordausrüstung nutzen können. An dessen Stelle können Sie aber auch eine **zweite Achterkabine wählen**.

The standard Dehler 42 has a front cabin, a spacious aft cabin starboard and a large storage room portside, which can be used for board equipment or as a sail locker. However, you can also **choose to have a second aft cabin** in this location.



The Smart Light System (SLS) dims each light in the owner's cabin to the desired brightness.

50

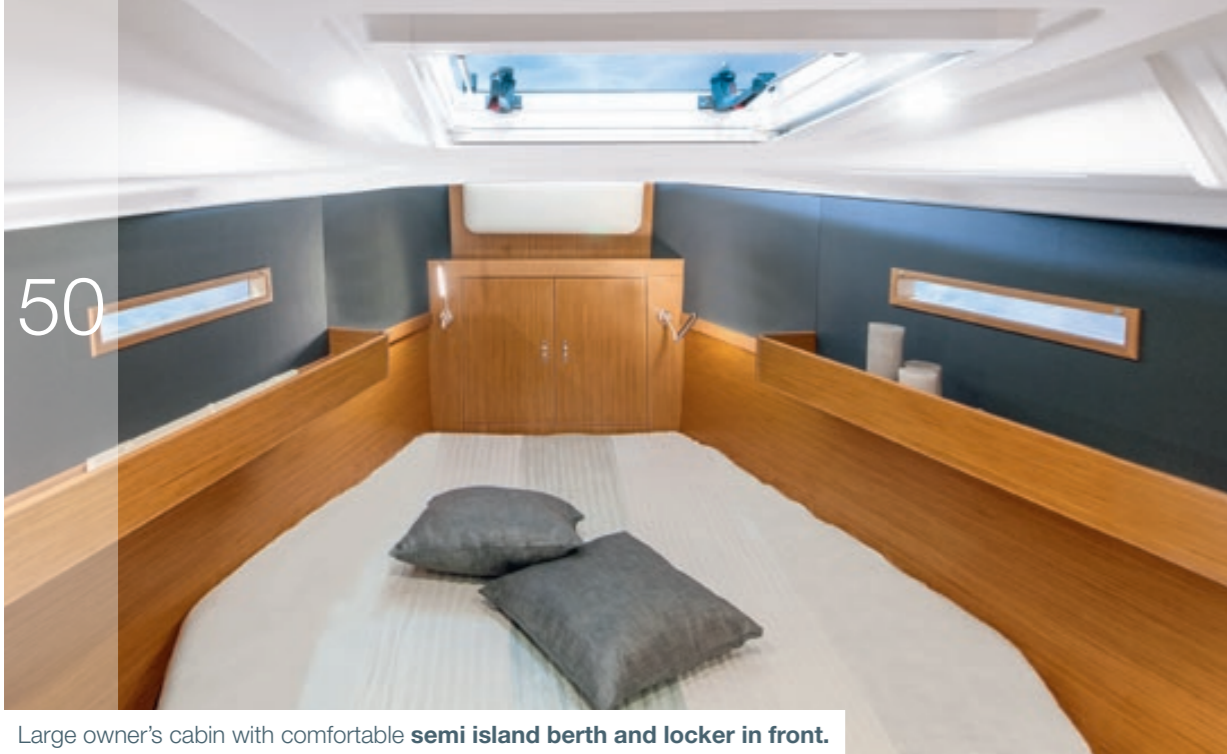

Large owner's cabin with comfortable **semi island berth and locker in front.**



**Additional spacious guest cabin** on portside.

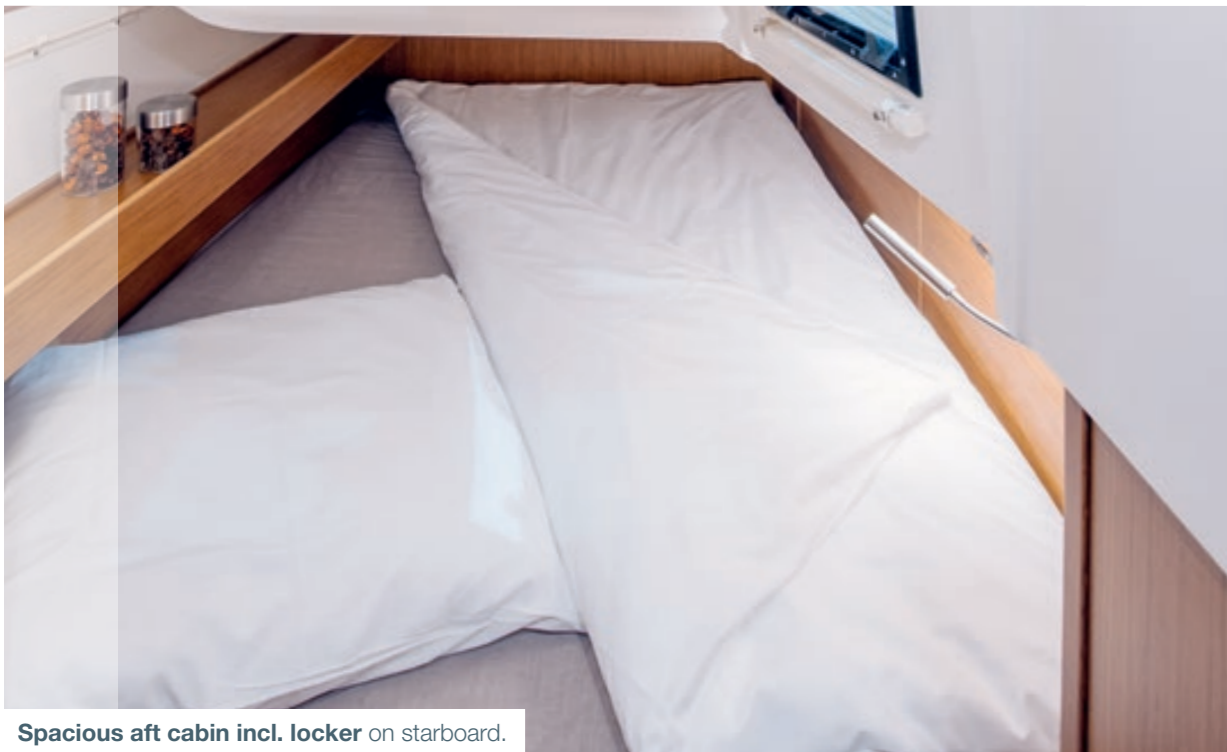

**Spacious aft cabin incl. locker** on starboard.



**Aft cabin** portside, huge storage space.

**DEHLER UNI DOOR CONCEPT**

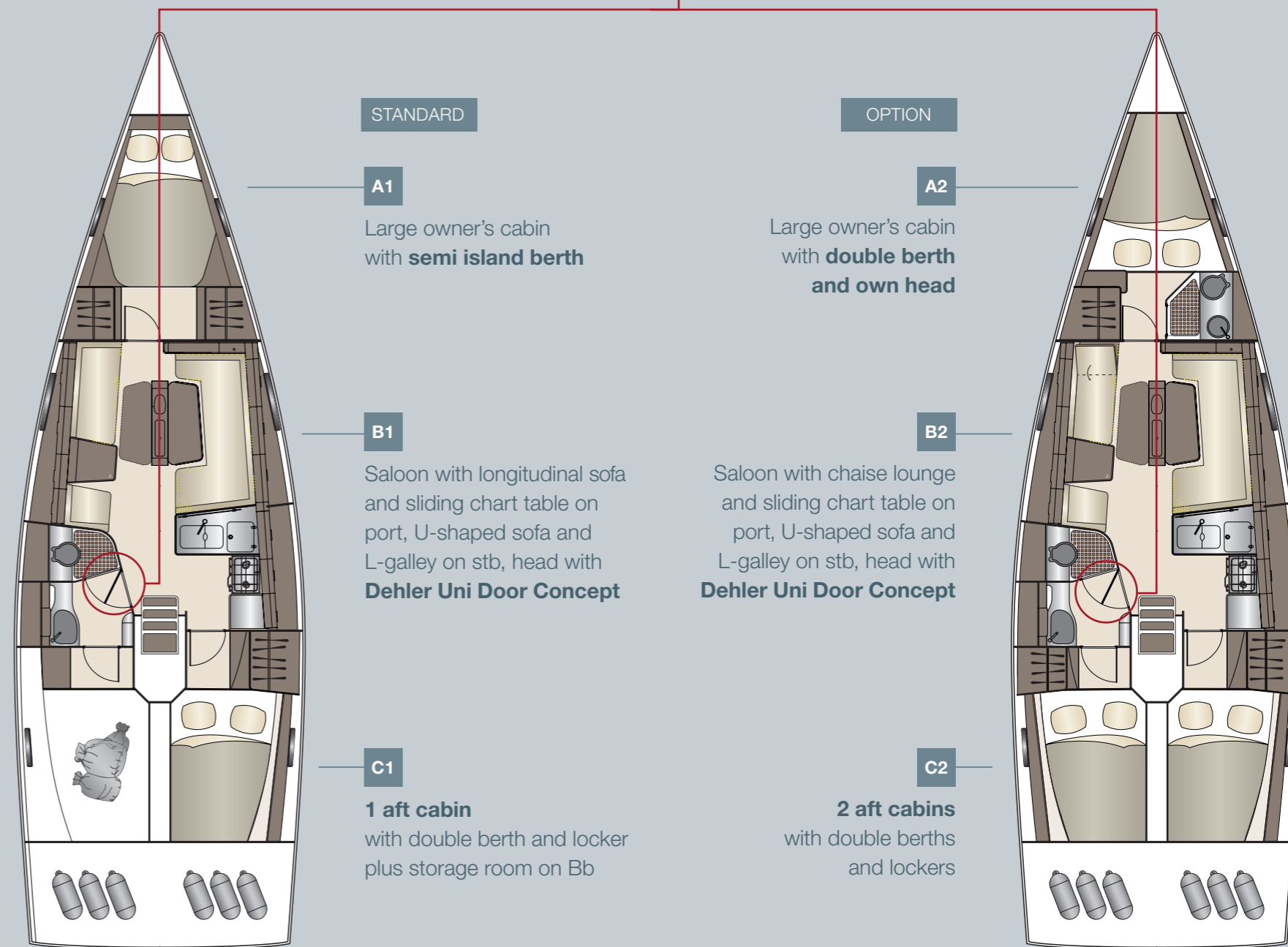



## INTERIOR

# MATERIALS & COLOURS

Verschiedene hochwertige Polstertexturen in unzähligen Farben, veredelt mit effektvollen Kedern. Unverwüstliches, angenehm weiches Leder. Dekorativ strukturierte Hölzer in allen Schattierungen von Mahagoni bis Kirsche. Da wird schon das Auswählen zum Erlebnis.

Exquisite fabric textures in a large range of colours, refined with decorative pipings. Resilient, pleasantly smooth leathers. Attractive wood structures in all varieties from mahogany to cherry. Choosing among these possibilities is an experience in itself.

## INTERIOR | UPHOLSTERY BALTIC

**Mix and match as you wish.**

All upholstery can be matched with the following piping colours: gold, silver, red, blue and black.

### STANDARD

cream / gold piping



### OPTIONS

blue / silver piping

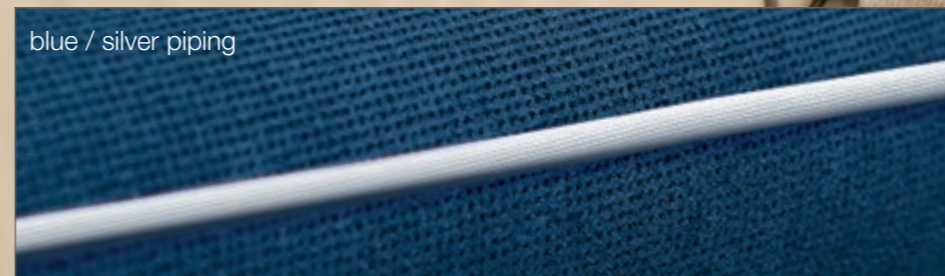

dark grey / red piping



red / black piping



chocolate / blue piping



# INTERIOR | UPHOLSTERY ATLANTIC

Mix and match as you wish.  
All upholstery can be matched with the following piping colours: gold, silver, red, blue and black.

## OPTIONS

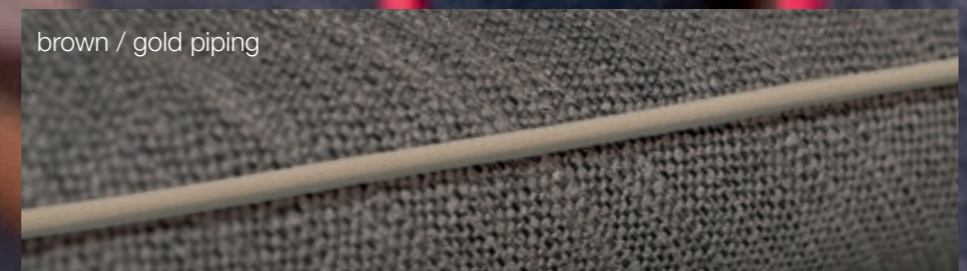
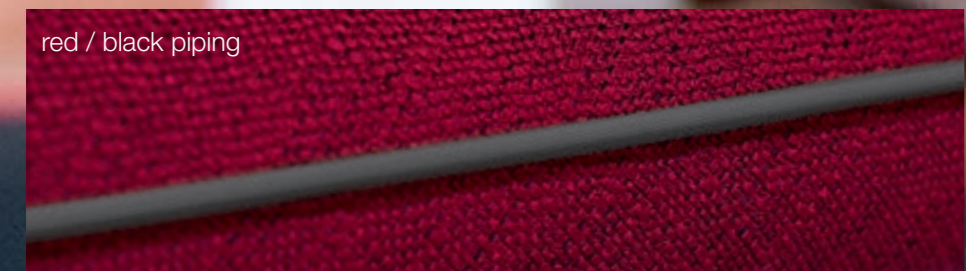

# INTERIOR | UPHOLSTERY PACIFIC

Mix and match as you wish.  
All upholstery can be matched with the following piping colours: gold, silver, red, blue and black.

## OPTIONS

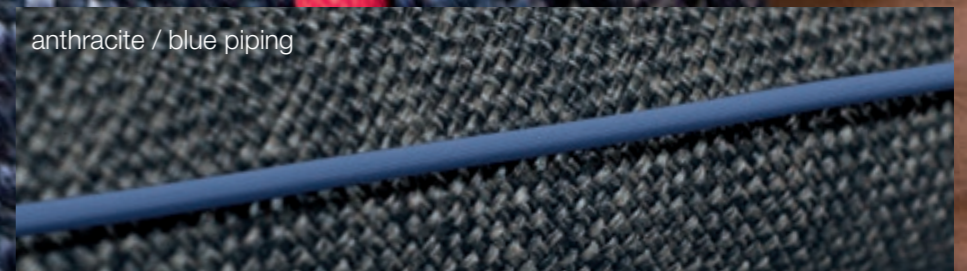
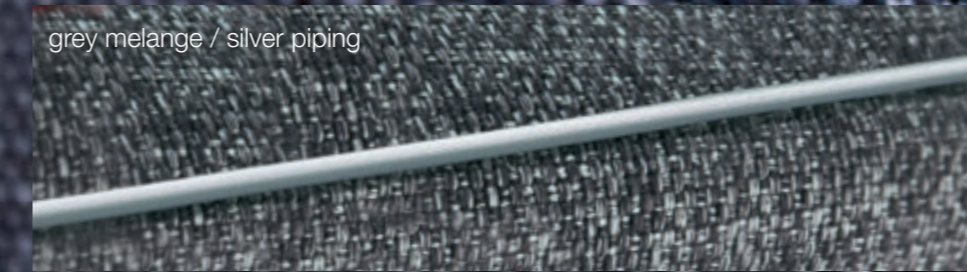

# INTERIOR | UPHOLSTERY ADRIATIC LEATHER

Mix and match as you wish.

All upholstery can be matched with the following piping colours: gold, silver, red, blue and black.

## OPTIONS

cream / black piping



blue / silver piping



mud / red piping



red / gold piping



chocolate / gold piping



# INTERIOR | SURFACES

## Worktop Galley

### STANDARD

white

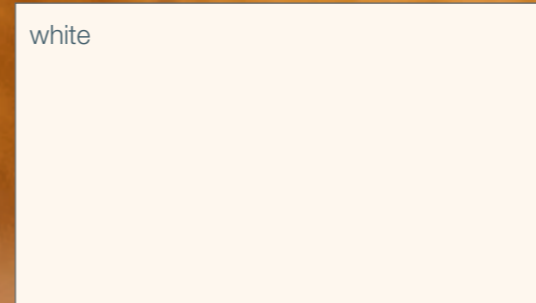

### OPTIONS

black



## Furniture Wood

### STANDARD

mahogany

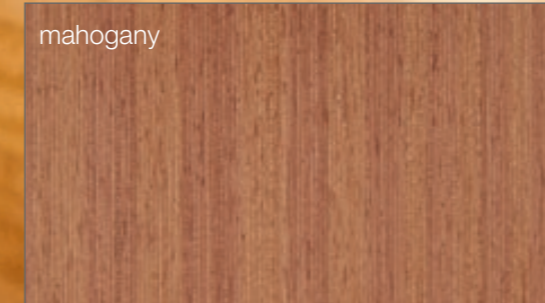

### OPTIONS

teak



cherry

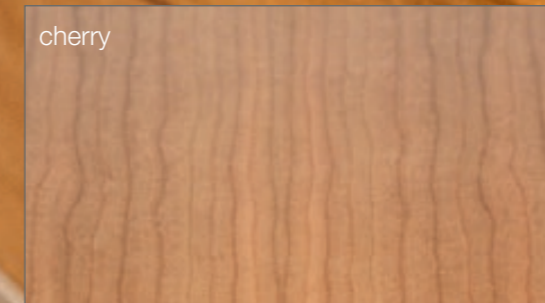

## Floorboards

### STANDARD

australian acacia

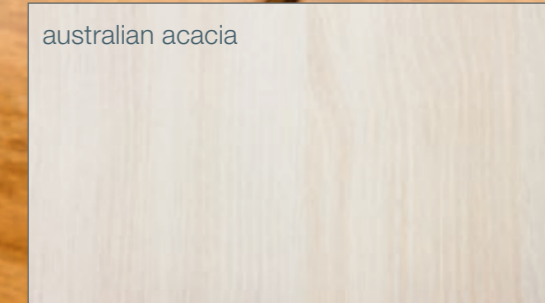

### OPTIONS

noce nero

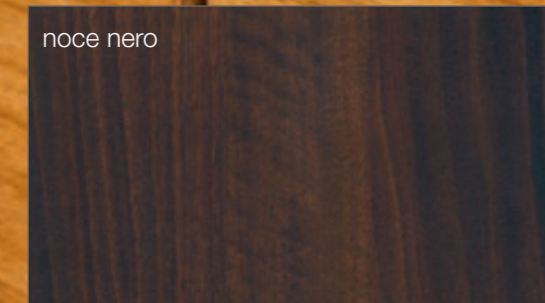

classic stripes

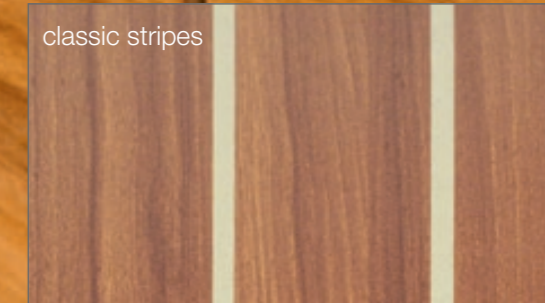

## TECHNOLOGY

DEEPER  
INSIDE

Das Innenleben der Dehler 42 ist durchdacht und perfektioniert bis ins letzte Detail. Es wird mit der führenden 3D-Software CATIA entworfen, die auch im Flugzeugbau zum Einsatz kommt. Bestens geschulte Ingenieure gehen in einer virtuellen Yacht ans Werk: Sie teilen Räume intelligent auf, verleihen den Einbauten ausgefallene Formen, erfinden neue Technik – und verwandeln damit die Gesetze der Physik in ein herausragendes Segel-Erlebnis.

The interior of the Dehler 42 is well thought-out and perfected down to the last detail. It is designed with the leading 3D software CATIA, which is also used for aircraft development. Working in a virtual yacht, the most qualified engineers divide spaces in a smart way, create extraordinary furniture shapes, invent new techniques – and doing so, they turn the laws of physics into an unrivalled sailing experience.

## 3D THINKING CREATES SPACE

## DEHLER UNI DOOR CONCEPT

The Dehler Uni Door Concept allows the use of two cabins at the same time. The door is hinged in a position that will either separate the head from the bathroom or close to the adjacent cabin to extend the space of the bath. Smart perfection!

## FULL SANDWICH HULL

The sandwich construction allows to make the hull thicker and lighter at the same time. In addition, it insulates against severe cold or heat.

- Sealing: saltwater-resistant gelcoat
- Core: high tech foam
- Outer skin: glass fibre laminated with vinylester resin

## ENGINE

The engine room is placed in a space saving manner beneath the companionway.

- All points used for regular maintenance are easily accessible
- Sound-insulated housing
- Comes with folding prop as standard

## DIESEL TANK (160 l)

- Perfect capacity for long-range cruising
- Optimum weight distribution due to central installation in transom
- Low center of gravity increasing the righting moment

## HULL WINDOWS

- More natural light inside the boat
- Extra large saloon window

## FRESH WATER TANK (315 l)

- Installed beneath the bow cabin
- More storage space in saloon
- Improves weight distribution of the entire yacht

## BOW SPRIT

- Increases sailing performance with asymmetrical headsails
- Allows for increased gennaker surfaces thus hence increasing downwind performance
- Easier gybing due to increased space between sail and forestay
- Allows for headsails such as FREERIDE SAIL

## UNDER DECK FURLER

- Clew can be attached directly above deck as with common non furling head stays
- maximum use of sail area
- Easy handling with small crew

## BOW THRUSTER

- Better manoeuvrability in narrow harbours
- No loss in speed due to retractability of thruster into the hull

## MAX BEAM SHROUDS

- High rigidity and stability: loads are directly distributed into hull structure
- No loss of tension or hull torsion hence increased performance
- Increased rig performance: wider spreaders result in a stiffer rig

## KEEL STEPPED MAST

- Leads forces directly into the carbon cage
- Increases rigidity, minimizes deck pressure
- Weighs less than a deck stepped mast
- Easier to trim, more seaworthy and secure

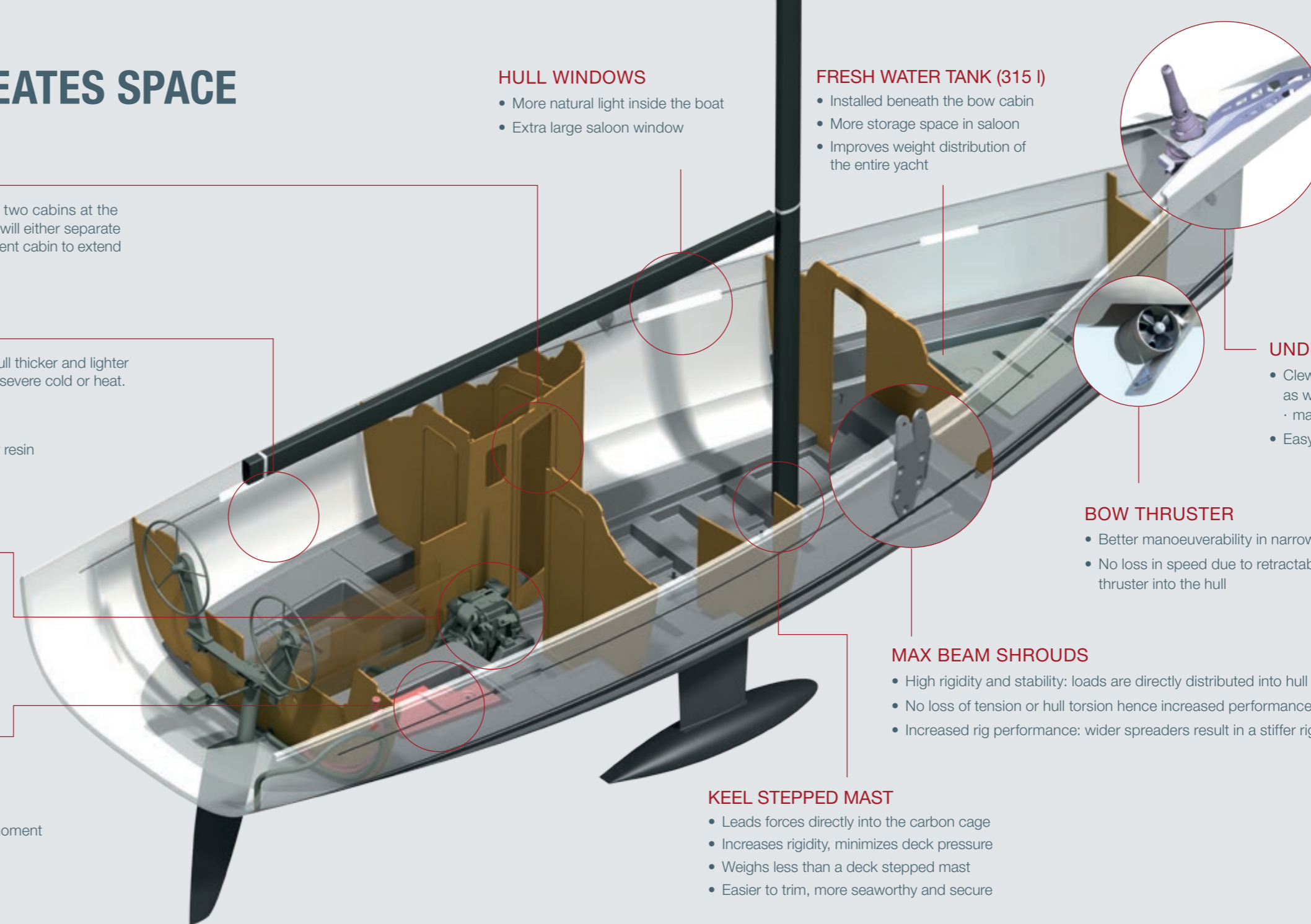

## VACUUM INFUSION TECHNOLOGY

### LIGHTER, STIFFER, STRONGER.

Dehler uses a state-of-the-art process to join the hull layers. After all air has been drawn off, resin is sucked into the laminate by vacuum pressure via carefully placed tubing. This technique delivers just the right amount of resin to every inch – without voids, dry or over-wetted spots.

- Stronger hull – 20% more rigidity
- Significant weight savings
- No osmosis due to high-quality vinylester resins

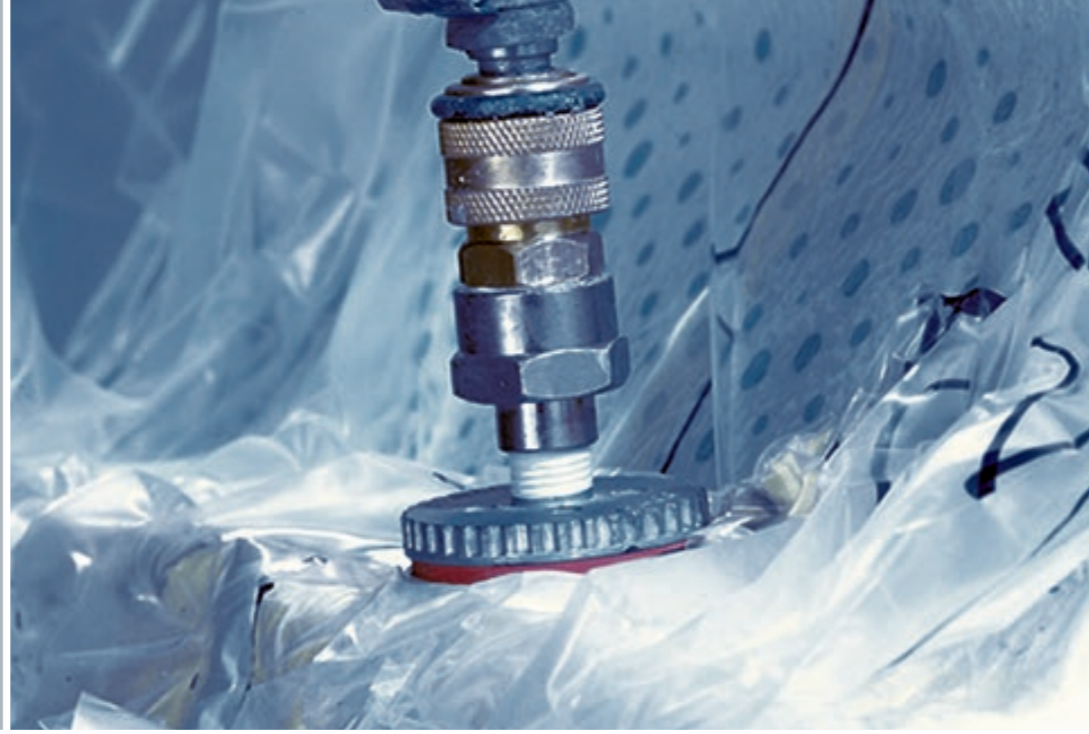

## KEEL TYPES

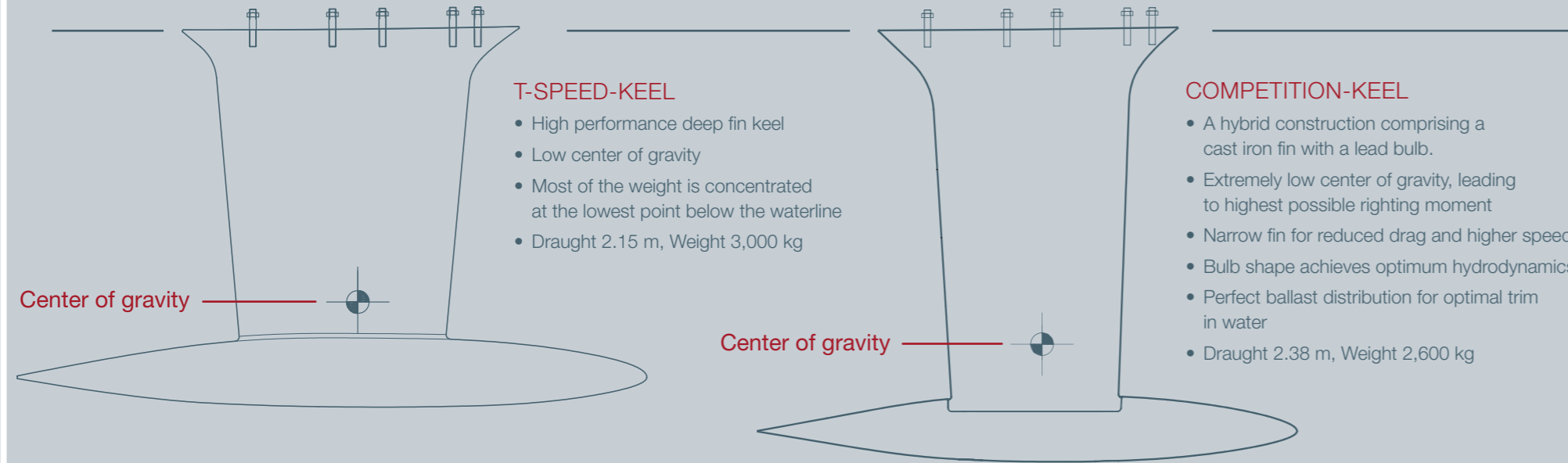

## DEHLER CARBON CAGE

A rigid floor structure is the secret in strong and well performing hulls. Being the backbone of the yacht, it directly affects the sailing performance. That is why the Dehler Carbon Cage comes as standard with the Dehler 42.

### HOW IT WORKS

The floor structure is reinforced with carbon fibre at thoughtfully selected points.

### LESS TORSION

The torsion of hull is minimised under high rig loads and in high seas, so it better withstands the forces of water and wind.

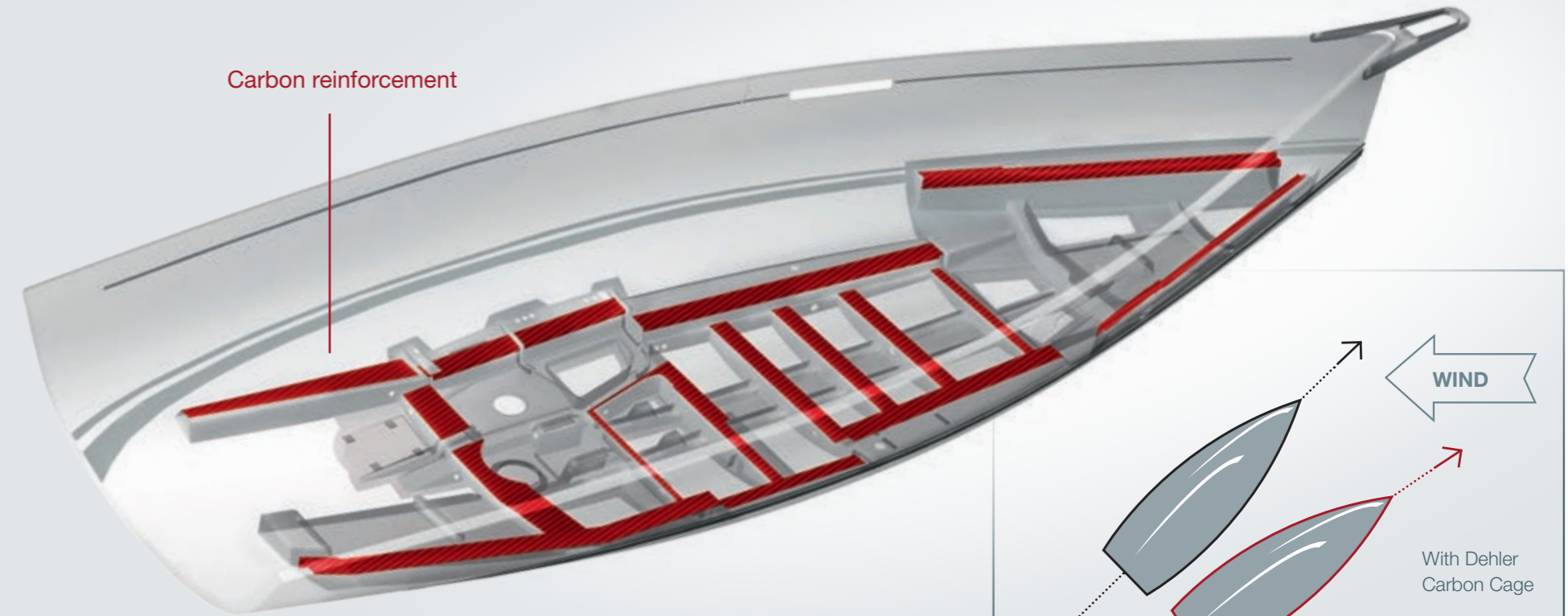

### A NEW LEVEL OF STABILITY

The rigidity of the mast base is increased by 50%; the inner grid is 25% stronger.

### HIGHER LONGEVITY

A hull less stressed lasts longer and extends the life span of your yacht.

### CLOSER TO THE WIND

The Dehler Carbon Cage benefits not only ambitious sailors, it also increases the general sailing fun onboard.

## 42

OPTIONS

AS YOU  
LIKE IT

Mit den folgenden Ausstattungsoptionen können Sie genau definieren, wie komfortabel bzw. wie sportlich Ihre Dehler 42 sein soll. Um Ihnen die Wahl ein bisschen zu erleichtern, bieten wir Ihnen einige Extras in besonders attraktiven Paketen an.

The following furnishing options allow you to define precisely how comfortable or sporty your Dehler 42 should be. To make your choice a little easier, we offer some extras, conveniently bundled in packages.

PACKAGES

CRUISING –  
FOR ENJOYABLE TIMES

PACKAGES

NAVIGATION –  
SETTING THE COURSE

PACKAGES

ENTERTAINMENT –  
THE SOUND OF THE SEA





**Steering wheels** Y spoke design, GRP-composite, colour black or white.

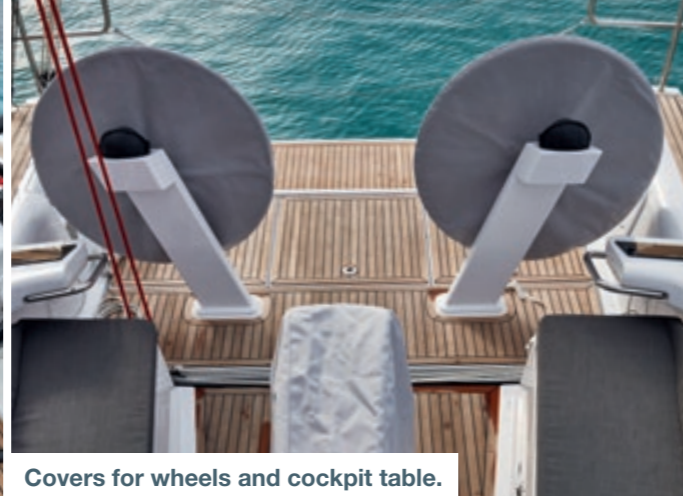

**Covers for wheels and cockpit table.**



**Electrical anchor windlass** with remote control.



**Elvstrøm** gennaker trioptimal.



**Cockpit table** with retractable light.

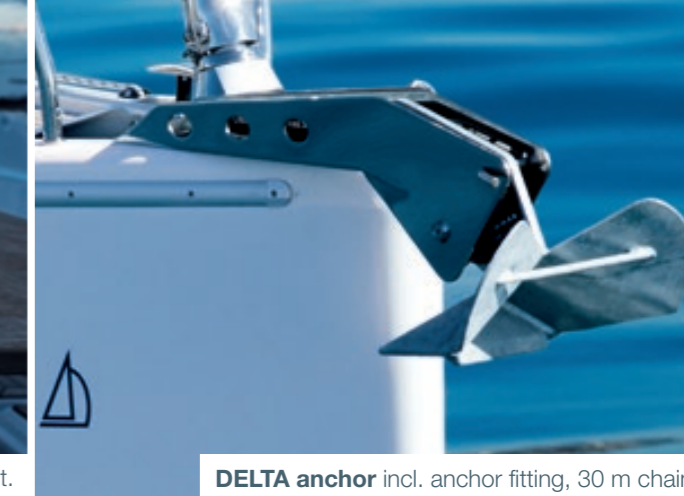

**DELTA anchor** incl. anchor fitting, 30 m chain.

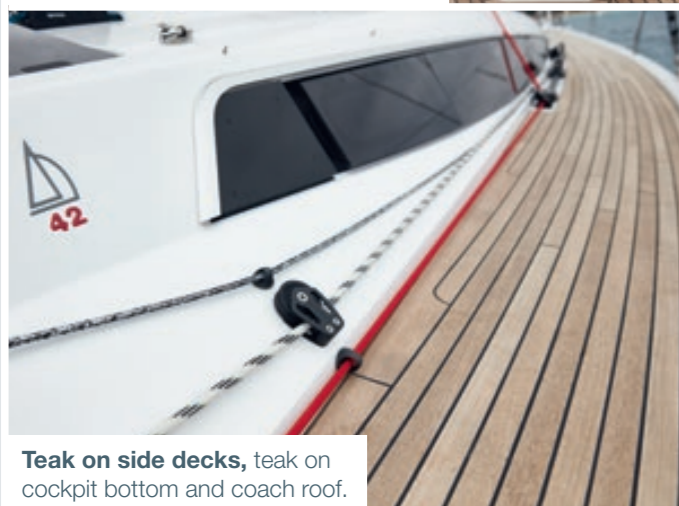

**Teak on side decks**, teak on cockpit bottom and coach roof.

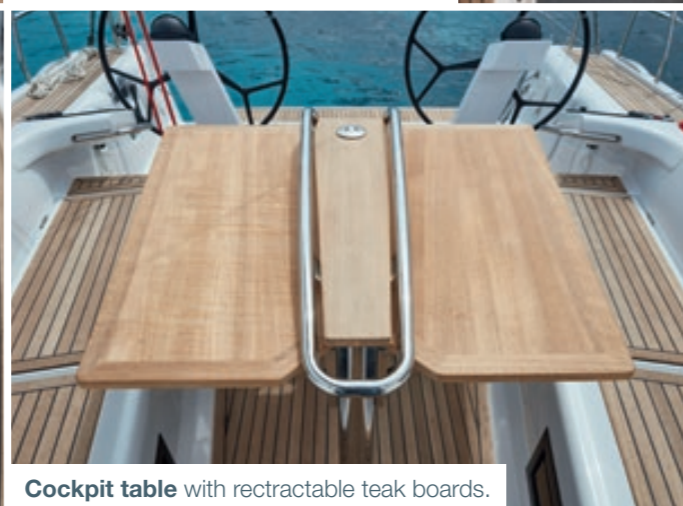

**Cockpit table** with retractable teak boards.

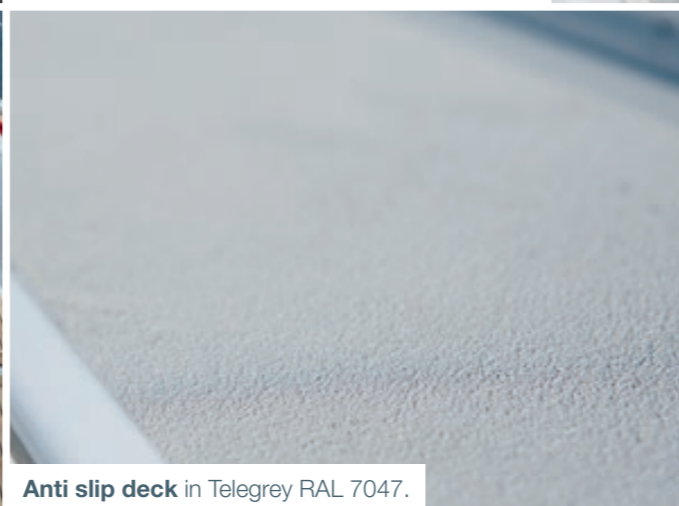

**Anti slip deck** in Telegrey RAL 7047.



**Halyard bags.**



**Composite bowsprit.**

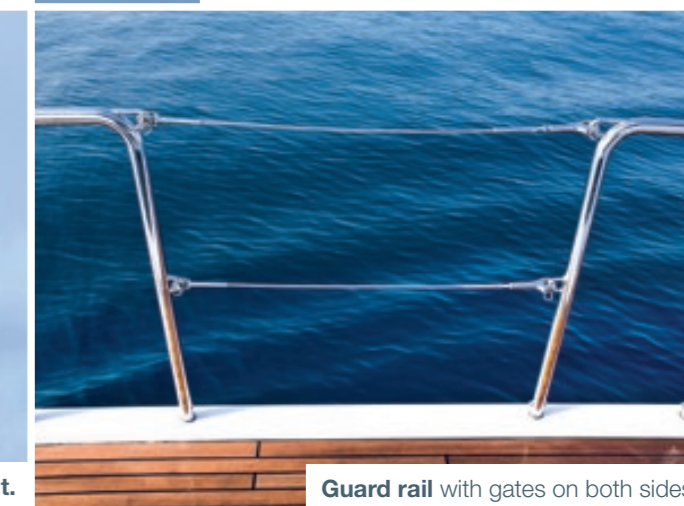

**Guard rail** with gates on both sides.

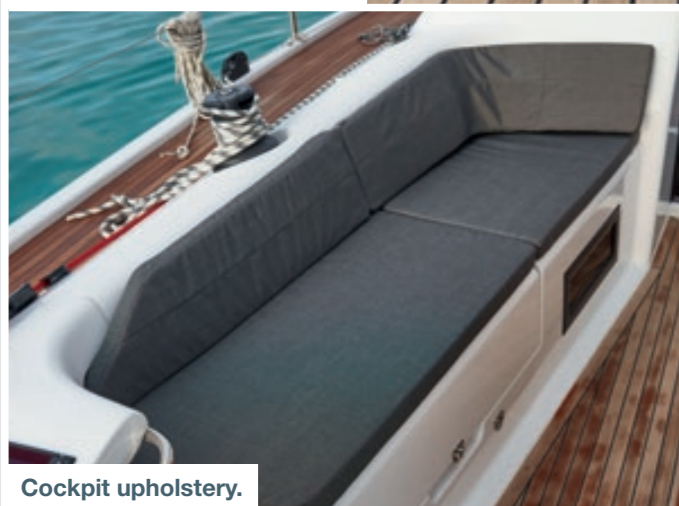

**Cockpit upholstery.**

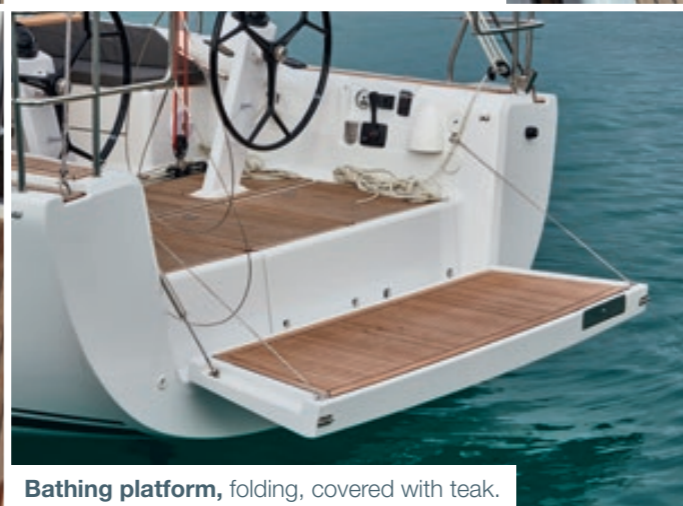

**Bathing platform**, folding, covered with teak.



**Retractable** bow thruster.

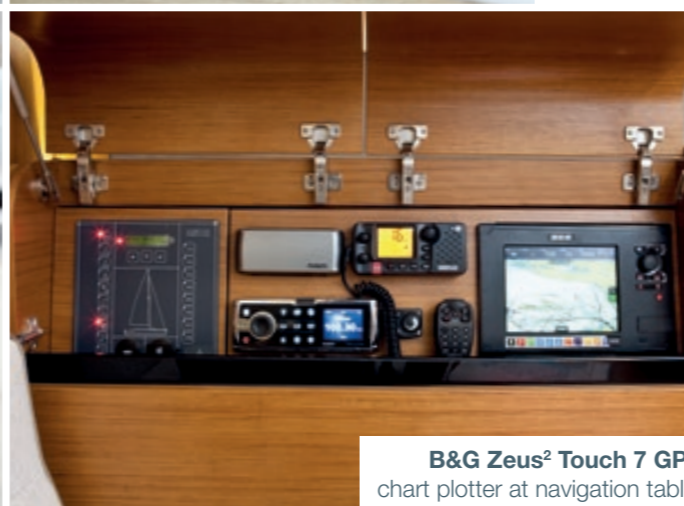

**B&G Zeus² Touch 7** GPS chart plotter at navigation table.



**2 halyard winches**, LEWMAR 40 Race, stb winch electrical.

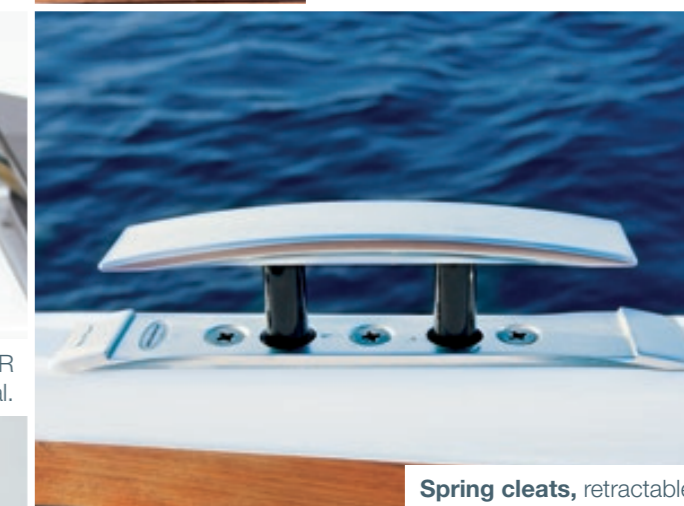

**Spring cleats**, retractable.





**Dehler Yachts**  
**Ladebower Chaussee 11**  
**D-17493 Greifswald**

**[www.dehler.com](http://www.dehler.com)**

Design: [www.smz.de](http://www.smz.de) | Print: Druckhaus Panzig | Photos: Nico Krauss, Peter-Paul Reinmuth, HanseYachts AG. This brochure is not contractual. The yachts depicted partly comprise special equipment not included in the standard scope of supply. Illustrations may not correspond with current versions. Subject to alterations in design and equipment without notice and errors excepted.

©2016 HanseYachts AG | CIBD42/C/0616